



ON LAND



OUTSTANDING  
**IN YOUR FIELDS**



# GO ELECTRIC

WITH OUR ELECTRIC AND HYBRID SYSTEMS

With more than a hundred years of experience in the design of innovative power transmission products, Twin Disc understands your needs and delivers the solutions that earn your confidence. Our innovative hybrid and electric systems support greener power transmission while delivering the reliability you expect from Twin Disc.

## GET TO KNOW YOUR OPTIONS

### FULL ELECTRIC

Eliminate the main diesel engine and its maintenance costs, and cut fuel costs and emissions. Configurable power-dense energy storage systems efficiently provide the energy needed to power the application.

### SERIAL HYBRID

Electric motors replace the traditional main diesel engines, drawing electric power from onboard gensets, or an energy storage system in combination with gensets.

### PARALLEL HYBRID

Pair the diesel engine with an electric motor. This configuration takes advantage of both, allowing for diesel-only, electric-only, peak shaving, and power boost operation.

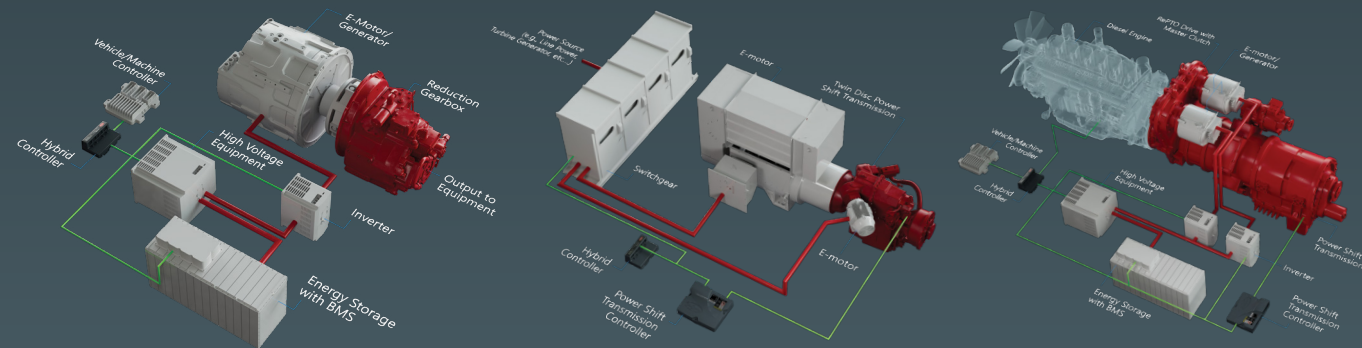

If you're ready to explore hybrid or electric power systems, Twin Disc is the smart place to start.

# A HISTORY OF MAKING MACHINES MORE PRODUCTIVE

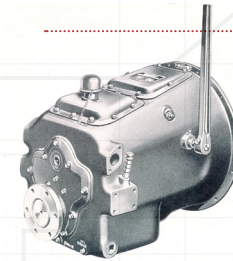

Since 1918 Twin Disc has been inventing, engineering and manufacturing products and developing technologies to make all kinds of machines work better. Our products transmit and manage power more efficiently, more reliably and with better operator interface. All the while contributing to a machine's higher uptime and lower operating costs. No one puts horsepower to work like Twin Disc.

## ACCOMPLISH MORE

With Twin Disc linking the power source and the work to be done, you've got the most efficient and durable transfer of power. The mechanical and control advantages Twin Disc products offer can help your machine and operator get more done in less time.

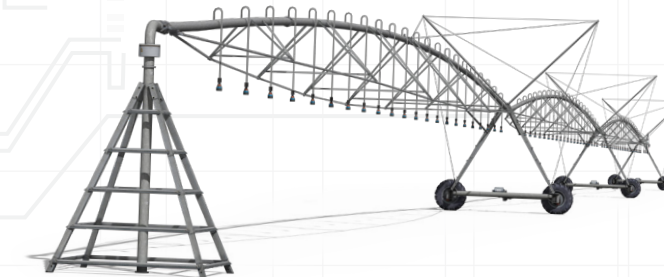

YOU CAN'T BEAT

# THE SYSTEM

Twin Disc's extensive array of power transmission products for land-based equipment allows you to tailor your system to yield the ultimate performance, control and reliability. All Twin Disc products have been engineered and manufactured to work seamlessly together to deliver unparalleled operating synergy.

Your application will benefit from power precisely managed through smooth shifting, exacting speed control, intrinsic driveline protection and multiple auxiliary-power options—all steeped in more than a century of rugged dependability in the most rigorous operating conditions.

Whatever the application, whatever the mission, your vehicle will perform better and more reliably with Twin Disc. Should any Twin Disc component need repair or replacement, our global sales and service network stands ready to support you wherever in the world your vehicle operates.

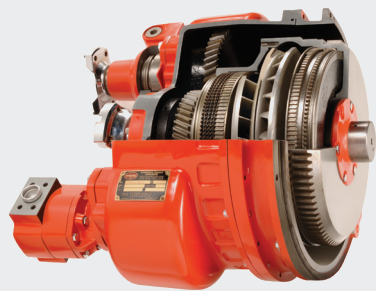

### TORQUE CONVERTERS

By transmitting torque through fluid mass in motion, Twin Disc converters eliminate mechanical connections and reduce or eliminate the need for shifting, clutching and declutching.

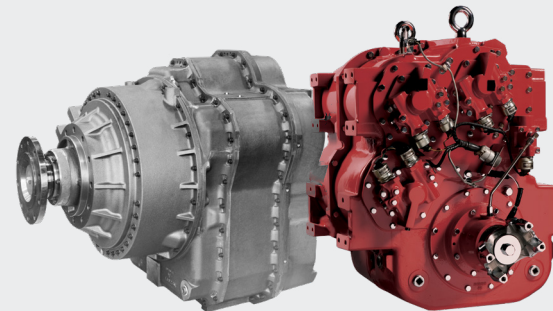

### POWER-SHIFT TRANSMISSIONS

Offering precise propulsion control for heavy-duty stationary and vehicular applications, our transmissions ensure high productivity, minimal downtime, and reliable operation through advanced technologies and customizable solutions for your transmission challenges.



### CLUTCHES

Rely on Twin Disc heavy-duty clutches for constant torque capacity without adjustment for friction plate wear. Pneumatically- and mechanically-actuated clutches can be integrated seamlessly into the machine cycle, with remote push-button or automatic control.



### PUMP DRIVES

Meet hydraulic system needs with industrial pump drives in a wide variety of gear ratios, including speed-increasing and speed-reducing configurations.

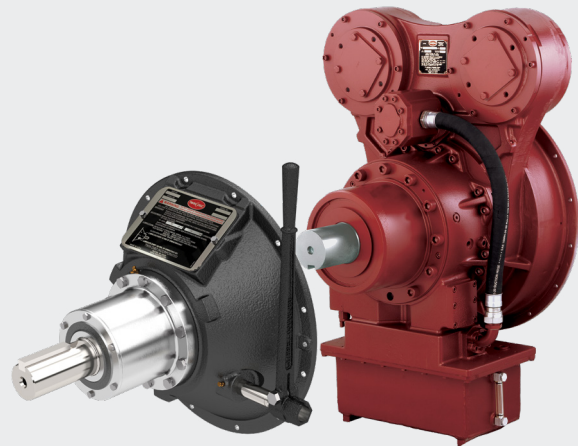

### POWER TAKE-OFFS

As the brand leader in both wet and dry clutch technology, we offer you unmatched expertise in transmitting power to machinery.



### GEAR BOXES

The modular design features clutchable input, housing with drive plate or stand-alone shaft input. Options include reduction and increase gear ratios on outputs, as well as output rotation options.

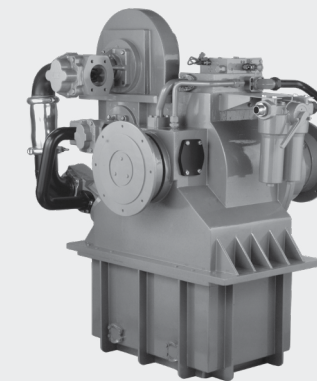

### UNIVERSAL CONTROL DRIVES

Twin Disc UCDs are engineered to deliver accurate, efficient control of the output speed. Increase precision for flow, pressure, speed, torque or power.



### INTEGRATED CONTROL SYSTEMS

Monitors engine speed and output speed for controlled engagement process, to help ensure precise clutch engagement without overloading the engine or damaging the clutch.



# OPERATOR APPRECIATION

In heavy-duty equipment working in rugged conditions, the operator must be aware of the moving parts of both the job and the machine. Our vast application experience gives us insight into a day in the life of a heavy-equipment operator. We design and build our products with the machine and operator in mind. They offer remarkable performance and incomparable durability. Plus, we incorporate state-of-the-art controls that make the operator more productive, more comfortable and safer.



GET IT DONE WITH TWIN DISC

## AGRICULTURE

- Irrigation
- Feed Mixers
- Manure Spreader

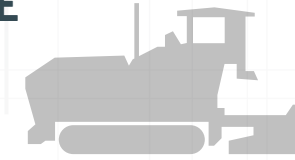

## AIRPORT GROUND SUPPORT

- Pushback Tractors
- Tugs
- Deicer
- APU/AC



## CONSTRUCTION

- Scrapers & Graders
- Compactors
- Rock Crushing/Processing

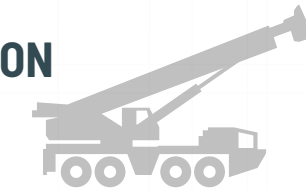

## RECYCLING

- Horizontal Grinder
- Tub Grinder
- Wood Chipper

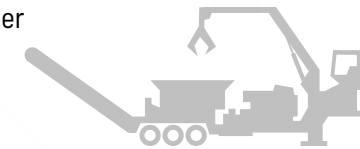

## PUMPING

- Irrigation
- Water Reclamation
- Dewatering
- Transfer Pumps

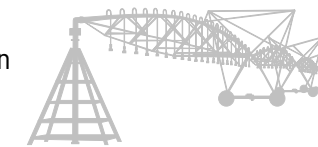

## FIRE AND RESCUE

- ARFF
- FiFi Pumps



## MATERIAL HANDLING/TRANSPORT

- Cranes
- Pallet Movers
- Carriers (Rough Terrain and Straddle)



## FORESTRY

- Tree Removal & Handling
- Forwarder
- Hauling



## RAIL

- Locomotives
- Rail Car Movers
- Rail Maintenance



## MUNICIPAL

- Snow Removal/Snow Throwers
- Street Sweepers
- Vacuum Trucks



## MILITARY

- Hauling
- Tank Retrieval
- Tracked Vehicles
- Amphibious Vehicles

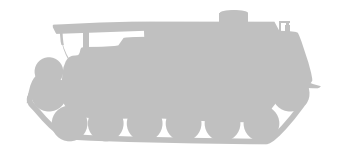

## MINING

- Haul Trucks
- Blast Hole Drill
- Rock Crushing/Processing



# MECHANICAL POWER TAKE-OFFS

Twin Disc offers more mechanical PTOs in more capacities than any other manufacturer. Available in sizes up to 533 mm (21 in), these reliable devices are ideal for basic-actuation installations. Where operator access is complicated by machinery configuration, Twin Disc also offers a line of remotely actuated mechanical PTOs offering safer and easier operation and greater equipment design flexibility.

## HAND LEVER ACTUATED POWER TAKE-OFFS

- SP Series: Counter-balanced toggle action over center clutch
- CA Series: Standard in-line
- C(X) Series: Standard in-line or side-load
- SL Series: Spring-loaded clutch
- TC Series: Spring-loaded, automotive-style clutch
- IB(F) Series: Inverted lever action centrifugal release clutch
- RB Series: Rubber block drive, non-clutchable disconnect, 11" single row, 14" double row
- PBL: Pilot bearingless

## HYDRAULICALLY ACTUATED POWER TAKE-OFFS

- RC Series: Remotely actuated via hydraulic circuit



Scan for more information on mechanical PTOs

MODEL	HOUSING SIZE (SAE J617)	FLYWHEEL SIZE (SAE J620)	MAX. INPUT TORQUE Nm (lb-ft)		MAX. INPUT POWER kW (hp)	MAX. INPUT SPEED (RPM)	
			ORGANIC	SINTERED		SOLID PLATES	SPLIT PLATES
CX106	4,5,6	6.5"	216 (159)	N/A	30 (40)	3,500	3,500
CX107	4,5,6	7.5"	237 (175)	N/A	40 (54)	3,200	3,200
CX108	3,4,5	8"	312 (230)	390 (288)	46 (61)	3,100	3,100
CX110	1,2,3,4	10"	445 (328)	556 (410)	72 (96)	3,930	3,500
CX111	1,2,3,4	11.5"	525 (387)	656 (484)	93 (124)	3,600	3,200
SP111	1,2,3	11.5"	617 (455)	771 (569)	93 (124)	3,600	3,200
SP211	1,2,3	11.5"	1,237 (909)	1,540 (1,136)	184 (247)	3,500	3,160
SP311	2,3	11.5"	2,197 (1,620)	N/A	277 (371)	3,000	3,000
SP114	0,1	14"	1,098 (810)	1,396 (1,030)	140 (188)	3,000	2,750
SP214	0,1	14"	2,197 (1,620)	2,793 (2,060)	281 (376)	3,000	2,750
SP314	0,1	14"	3,295 (2,430)	4,195 (3,094)	421 (564)	3,000	2,700
SP218	00,0	18"	5,424 (4,000)	6,776 (5,000)	464 (622)	2,350	2,100
SP318	0	18"	8,136 (6,000)	10,165 (7,500)	696 (933)	2,350	2,100
SP321	00	21"	9,126 (6,730)	11,430 (8,412)	947 (1,270)	1,800	1,800
IB214	0,1	14"	2,197 (1,620)	2,745 (2,025)	295 (395)	2,400	N/A
IB314	0,1	14"	3,295 (2,430)	4,119 (3,038)	553 (741)	2,400	N/A
IB318	0	18"	8,136 (6,000)	10,169 (7,500)	913 (1,224)	2,200	N/A
IB321	00	21"	9,125 (6,730)	11,389 (8,400)	1,244 (1,667)	2,200	N/A
CA110	3,4	10"	610 (450)	N/A	71 (96)	3,100	N/A
CA210	3	10"	1,220 (900)	N/A	143 (192)	3,100	N/A
SL111	3,4	11.5"	475 (350)	N/A	93 (124)	2,625	N/A
SL211	1,2,3	11.5"	708 (522)	N/A	184 (247)	2,750	N/A
SL214	1	14"	1,342 (990)	N/A	281 (376)	1,800	N/A
TC113	3	13"	610 (450)	N/A	149 (200)	3,400	N/A
PBL106	4,5,6	6.5"	216 (159)	N/A	30 (40)	3,200	N/A
PBL107	4,5,6	7.5"	237 (175)	N/A	40 (54)	3,200	N/A
PBL108	3,4,5	8"	312 (230)	390 (288)	46 (61)	3,100	3,100
PBL110	1,2,3,4	10"	445 (328)	556 (410)	72 (96)	3,930	3,500
PBL111	1,2,3	11.5"	525 (387)	656 (484)	93 (124)	3,600	3,200
RC211	1,2,3	11.5"	1,232 (909)	1,540 (1,136)	184 (247)	3,500	3,000
RC311	1,2,3	11.5"	2,196 (1,620)	N/A	277 (371)	3,000	N/A
RC214	0,1	14"	2,195 (1,620)	2,748 (2,025)	281 (376)	3,000	2,750
RC314	0,1	14"	3,297 (2,430)	4,125 (3,040)	421 (564)	3,000	2,750
RC218	00,0	18"	5,424 (4,000)	6,776 (5,000)	464 (622)	2,350	2,100
RC318	0	18"	8,136 (6,000)	10,165 (7,500)	696 (933)	2,350	2,100

# HYDRAULIC POWER TAKE-OFFS

These latest additions to the Twin Disc PTO line are available in side-load straddle-bearing clutched models, in-line clutched models and non-clutched models. Applications for hydraulic clutches are similar to those for the mechanical PTOs. Hydraulic clutches can be used wherever a disconnect is required between the driven equipment and the prime mover, to reduce start-up and braking load shocks to the driveline.

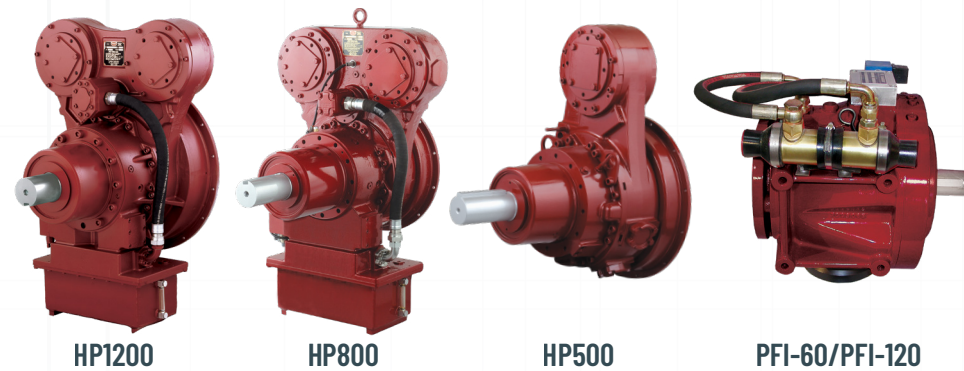

## FEATURES

- Hydraulically-actuated self-adjusting clutch
- Suitable for in-line and side-load applications
- Advanced control system for smooth engagement
- High side-load capability
- Optional integral reservoir

Scan for more information on hydraulic PTOs

MODEL	MAXIMUM POWER RATING			PUMP TOWER CAPACITY		HOUSING SIZE (SAEJ617)	FLYWHEEL SIZE (SAEJ620)	MAX. INPUT SPEED (RPM)
	@1200 RPM	@1800 RPM	@2100 RPM	1 TOWER (2 PADS)	2 TOWER (4 PADS)			
HP1200P	617 kW (828 hp)	932 kW (1,243 hp)	1,080 kW (1,448 hp)	298 kW (400 hp)	410 kW (550 hp)	0,1	14", 18"	2,250
HP1200I	617 kW (828 hp)	932 kW (1,243 hp)	1,080 kW (1,448 hp)	298 kW (400 hp)	410 kW (550 hp)	0,1	14", 18"	2,250
	@1200 RPM	@1800 RPM	@2200 RPM					
HP800P	397 kW (533 hp)	597 kW (800 hp)	729 kW (978 hp)	298 kW (400 hp)	336 kW (450 hp)	0,1	14", 18"	2,300
HP800I	397 kW (533 hp)	597 kW (800 hp)	729 kW (978 hp)	298 kW (400 hp)	336 kW (450 hp)	0,1	14", 18"	2,300
HP500	248 kW (333 hp)	373 kW (500 hp)	456 kW (611 hp)	298 kW (400 hp)	336 kW (450 hp)	1, 2, 3	14", 11.5", 10"	2,300

MODEL	MAXIMUM POWER RATING	MAXIMUM TORQUE CAPACITY	HOUSING SIZE (SAEJ617)	FLYWHEEL SIZE (SAEJ620)	MAX. INPUT SPEED (RPM)
PFI60	205 kW (275 hp)	600 Nm (442 lb-ft)	1, 2, 3	11.5"	3,200
PFI120	381 kW (510 hp)	1,200 Nm (885 lb-ft)	1, 2, 3	11.5", 14"	3,000

# CLUTCHES

Available in sizes up to 1,067 mm (42 in), Twin Disc P0 air clutches are designed to give the user maximum dependability and lowest possible installation and operating costs. They are used extensively by leading manufacturers of drilling rigs, drawworks, rock crushers, tractor winches, pipe-extruding machines, machine tools, pug mills and other industrial equipment.



## FEATURES

- 8" through 42" clutches
- Single, double, and triple organic drive plate
- Capacity from 526 to 280,692 Nm (388 to 207,000 lb-ft)
- Air actuated clutch
- Integral quick release valve
- Heavy, rugged teeth for long life

MODEL	MAX. INPUT TORQUE Nm (lb-ft)	MAX. INPUT POWER kW (hp)	MAX. INPUT SPEED (RPM)	
			SOLID PLATES	SPLIT PLATES
P0108	396 (292)	34 (45)	3,600	3,050
P0208	793 (585)	48 (65)	4,200	3,650
P0308	1,189 (877)	63 (85)	4,250	3,650
P0110	671 (495)	50 (67)	3,100	2,650
P0210	1,342 (990)	75 (100)	3,600	2,900
P0310	2,013 (1,485)	101 (135)	3,650	2,950
P0111	1,180 (870)	63 (85)	2,850	2,200
P0211	2,359 (1,740)	97 (130)	2,850	2,200
P0311	3,539 (2,610)	130 (175)	3,250	2,720
P0114	3,813 (2,812)	97 (130)	2,400	1,950
P0214	7,626 (5,625)	149 (200)	2,500	1,950
P0314	11,439 (8,437)	194 (260)	2,500	1,920
P0118	7,575 (5,587)	164 (220)	1,800	1,550
P0218	15,151 (11,175)	242 (325)	1,950	1,550
P0318	22,726 (16,762)	321 (430)	2,050	1,550
P0124	17,592 (12,975)	291 (390)	1,400	1,150
P0224	35,183 (25,950)	429 (575)	1,450	1,000
P0324	52,775 (38,925)	574 (770)	1,450	975
P0230	66,096 (48,750)	671 (900)	1,100	925
P0330	99,144 (73,125)	895 (1,200)	1,100	925
P0236	113,075 (83,400)	966 (1,295)	825	600
P0336	169,613 (125,100)	1,230 (1,650)	1,100	850
P0342	280,654 (207,000)	1,667 (2,235)	1,100	825
CL105	176 (130)	22 (29)	3,500	3,200
CL205	353 (260)	43 (58)	3,500	2,950
CL106	186 (137)	30 (40)	3,500	2,850
CL206	373 (275)	60 (81)	3,500	3,150
CL306	559 (312)	90 (121)	3,500	2,250
CL108	325 (240)	46 (61)	3,100	2,550
CL208	651 (480)	92 (123)	3,100	3,100
CL308	976 (720)	137 (184)	3,100	3,100
CL110	526 (388)	72 (96)	2,675	2,100
CL210	1,052 (776)	143 (192)	3,600	2,750
CL310	1,578 (1,164)	215 (288)	3,650	2,650
CL111	610 (450)	93 (124)	2,325	1,800
CL211	1,220 (900)	184 (247)	2,325	1,800
CL311	1,831 (1,350)	277 (371)	3,250	2,450

Scan for more information on clutches

# GEAR BOXES

Our gear boxes are built to withstand the most rigorous applications. Their modular design features cast iron housings, shaved helical gears and case hardened shafts. Twin Disc gearboxes are available with reduction and increasing gear ratios on outputs, along with output rotation options.

**DID YOU KNOW?** Twin Disc marine transmissions can be used for land-based applications. Contact the Twin Disc Applications Engineering Department for more information.



Scan for more information on gear boxes

## FEATURES

- SAE #4 thru SAE #0
- Independent mount available\*
- SAE 8" thru SAE 14"
- Clutch or rubber block drive
- Keyed or splined output shaft
- Limited side-load capacity
- Over speed or reduction ratios available

\* Clutch input required

MODEL	HOUSING SIZE (SAEJ617)	FLYWHEEL SIZE (SAEJ620)	MAXIMUM INPUT TORQUE Nm (lb-ft)	RATIO (X:1)	MAXIMUM INPUT SPEED (RPM)
RM20D	4, 5	6.5", 7.5"	75 (56)	0.57	2,700
				1.00	
			55 (41)	2.00	3,500
			50 (37)	2.71	
RM20S	4, 5	6.5", 7.5"	75 (56)	0.64	2,800
			55 (41)	1.89	3,500
			50 (37)	2.47	
RM45D	4, 5	6.5", 7.5", 8.0"	165 (122)	0.67	2,800
			161 (119)	1.00	
			121 (89)	2.00	3,500
			100 (74)	2.88	
			80 (59)	3.40	
				4.00	
			71 (52)	5.00	
RM45S	4, 5	6.5", 7.5", 8.0"	161 (119)	0.57	2,700
			130 (96)	1.50	3,500
			110 (81)	1.81	
			91 (67)	2.65	
			71 (52)	4.09	
RM70D	3, 4	10.0"	290 (215)	0.58	2,500
				1.00	3,200
			250 (185)	1.53	
			210 (156)	2.00	
			190 (141)	2.45	
			170 (126)	3.00	
			155 (115)	3.75	

MODEL	HOUSING SIZE (SAEJ617)	FLYWHEEL SIZE (SAEJ620)	MAXIMUM INPUT TORQUE Nm (lb-ft)	RATIO (X:1)	MAXIMUM INPUT SPEED (RPM)
RM70S	3, 4	10.0"	280 (207)	0.50	2,400
				0.63	2,600
			260 (193)	0.70	2,700
			220 (163)	1.32	3,200
			200 (148)	1.88	
			160 (119)	2.73	
			120 (89)	3.25	
RM100D	3, 4	10.0", 11.5"	400 (296)	0.60	2,400
				0.67	2,500
				1.00	3,000
			380 (281)	1.20	
			350 (259)	1.50	
			320 (237)	2.00	
			260 (193)	3.00	
			230 (170)	3.66	
	5.00				
RM100S	3, 4	10.0", 11.5"	400 (296)	0.51	2,000
			380 (281)	0.81	2,700
				1.23	3,000
			350 (259)	1.50	
			320 (237)	1.86	
			260 (193)	2.80	
230 (170)	4.21				
RM120D	1, 2, 3, 4	11.5"	1,000 (741)	0.50	2,000
			880 (652)	1.02	2,500
			740 (548)	1.70	
			700 (519)	2.00	
			510 (378)	3.00	
			450 (333)	3.55	
RM120S	1, 2, 3, 4	11.5"	830 (615)	0.67	2,000
				1.50	2,500
			500 (370)	2.00	
				2.60	
				2.80	
	3.00				
RM150D	1, 2, 3	11.5", 14.0"	1,500 (1,111)	0.66	2,000
			1,450 (1,074)	1.02	2,500
			1,250 (926)	1.47	
			1,090 (807)	2.00	
			850 (630)	3.04	
RM150S	1, 2, 3	11.5", 14.0"	950 (704)	1.51	2,500
				1.96	
			640 (474)	2.70	

# PUMP DRIVES

The Twin Disc line of pump drives meets a broad range of hydraulic system set-ups and applications. These drives are available in a wide variety of gear ratios, including both speed increasing and reducing configurations.

The modular design of these pump drives enables you to choose from several input options, including a rubber block drive or clutch to match your SAE engine flywheel dimensions. Independent mounting is also an option, both direct and with a clutch.

For your pump mounting requirements, Twin Disc offers standard SAE adaptor kits as well as a wide variety of non-SAE adaptations for your special needs.

## FEATURES

- Cast iron housings
- Case hardened and ground spur gears, except select models where gears are shaved
- Ball bearings
- Case hardened shafts
- Viton seals on input shaft
- Output rotation opposite the direction of input rotation
- Gear ratios identical on all outputs for each model

## SINGLE PAD (DIRECT ENGINE MOUNT)

### Flywheel Housing

- SAE #6 to SAE #1

### Flywheel Connection

- SAE 6.5" to SAE 11.5"
- Non-SAE mounts available

### Capacity

- SAE 6.5" to SAE 10" = 221 lb-ft (300 Nm)
- SAE 11-1/2" = 479 lb-ft (650 Nm)

## PUMP MOUNT

- SAE A, B, C & D
- 2 and 4 bolt designs
- DIN standard available

## PUMP SPLINE

- SAE A, B, BB, C, CC & D
- DIN standard available
- Keyed bores available
- Metric and US standard



Scan for more information on pump drives

	MODEL	MAXIMUM INPUT TORQUE Nm (lb-ft)	MAXIMUM INPUT SPEED (RPM)	MAXIMUM INPUT POWER kW (hp)	MAXIMUM TORQUE/PAD Nm (lb-ft)
SINGLE PAD*	AM110	540 (398)	3,200	181 (245)	540 (398)
	AM216	631 (465)	3,200	205 (275)	315 (232)
DUAL PAD*	AM220	1,081 (797)	3,200	355 (476)	540 (398)
	AM230	1,620 (1,195)	2,600	431 (577)	810 (597)
	AM232	2,299 (1,696)	2,400	566 (758)	1,150 (848)
	AM270	3,501 (2,582)	2,600	701 (939)	1,751 (1,291)
THREE PAD*	AM320	631 (465)	3,200	205 (275)	315 (232)
	AM330	1,081 (797)	3,200	355 (476)	540 (398)
	AM345	1,620 (1,195)	2,600	431 (577)	810 (597)
	AM365	2,900 (2,139)	2,200	671 (899)	1,450 (1,069)
	AM370	3,501 (2,582)	2,600	701 (939)	1,751 (1,291)
FOUR PAD*	AM450	2,601 (1,918)	2,400	640 (858)	1,300 (959)
	AM480	3,801 (2,803)	1,800	701 (939)	1,900 (1,401)
	AM481	5,500 (4,057)	1,800	850 (1,140)	1,900 (1,400)

\* Ratings for 1:1 ratio

MODEL	MAXIMUM INPUT POWER @ 1800 RPM kW (hp)	MAXIMUM INPUT SPEED (RPM)	PUMP TOWER CAPACITY		RATIOS (X:1)
			1 TOWER (2 PADS)	2 TOWER (4 PADS)	
AM050	373 (500)	2,600	224 (300)	224 (300)	1.00, 0.87, 0.77
AM080	597 (800)	3,000	261 (350)	336 (450)	1.00, 0.87, 0.77





# TRANSMISSION PRODUCTS

Twin Disc offers a comprehensive range of heavy-duty automatic transmissions for rugged applications requiring precise and customizable shift control and power-splitting capabilities. Available in sizes up to 2,460 kW (3,300 hp), Twin Disc transmissions combine ease of operation with robust design and durable components to excel in the most demanding situations.

All-wheel-drive on/off-highway vehicles such as Aircraft Rescue and Fire Fighting (ARFF) benefit from smooth, fast acceleration. When the transmission is combined with a Twin Disc torque converter, the system provides power dividing capabilities, which allow “pump and roll” operation. This industry-leading feature eliminates the need for costly auxiliary engine-driven pumps or additional power dividing gearboxes.

Oil and gas operations benefit from Twin Disc’s highly reliable, low-maintenance transmission systems to achieve maximum productivity at the well site.

Military vehicles utilize Twin Disc automatic transmissions to confidently deliver personnel and supplies to and from the front line.

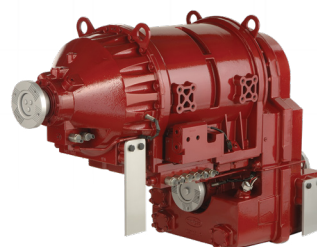
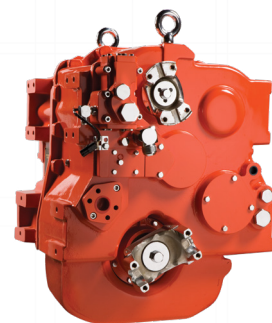
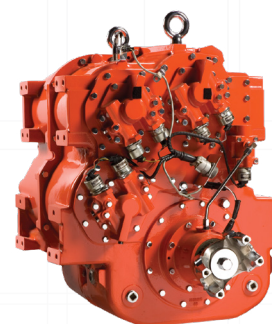

TD61-1179 AWD								
GROSS INPUT POWER	402 kW (540 hp) @2,100							
GROSS INPUT TORQUE	2,644 Nm (1,950 lb-ft)							
MAXIMUM INPUT SPEED	2,300 rpm							
WEIGHT, DRY	770 kg (1,700 lbs)							
LENGTH	887 mm (34.9 in)							
WIDTH	660 mm (25.9 in)							
HEIGHT	815 mm (32.1 in)							
GEAR RATIOS								
1ST	2ND	3RD	4TH	5TH	6TH	REV	OVERALL	
6.03	3.95	2.61	1.70	1.12	0.74	6.70	8.15	

TD61-1180 AWD								
GROSS INPUT POWER	275 kW (370 hp) @2,100							
GROSS INPUT TORQUE	2,644 Nm (1,950 lb-ft)							
MAXIMUM INPUT SPEED	2,300 rpm							
WEIGHT, DRY	770 kg (1,700 lbs)							
LENGTH	887 mm (34.9 in)							
WIDTH	660 mm (25.9 in)							
HEIGHT	815 mm (32.1 in)							
GEAR RATIOS								
1ST	2ND	3RD	4TH	5TH	6TH	REV	OVERALL	
6.70	4.39	2.90	1.89	1.24	0.82	7.44	8.17	

TAD81-4001								
GROSS INPUT POWER (ARFF ONLY)	596 kW (800 hp) @1,900							
GROSS INPUT TORQUE	2,618 Nm (3,550 lb-ft)							
MAXIMUM INPUT SPEED	1,900 rpm							
WEIGHT, DRY	1,114 kg (2,455 lbs)							
LENGTH	1,619 mm (63.7 in)							
WIDTH	641 mm (25.2)							
HEIGHT	988 mm (38.8 in)							
GEAR RATIOS								
1ST	2ND	3RD	4TH	5TH	6TH	7TH	8TH	REV OVERALL
6.50	4.02	2.95	2.07	1.55	1.07	0.81	0.71	5.82 9.17

*In-line and commercial configurations available. Please contact Twin Disc Applications Engineering at [applications@twindisc.com](mailto:applications@twindisc.com) for more details.*

If your application involves critical equipment, whether vehicles or machines, that must be ready to deploy and perform well when you demand it, Twin Disc products will meet and exceed your power transmission requirements.

TA90-7500										
GROSS INPUT POWER	1,939 kW (2,600 hp) @1,900									
GROSS INPUT TORQUE	10,460 Nm (7,715 lb-ft)									
MAXIMUM INPUT SPEED	1,900 rpm									
WEIGHT, DRY	2,041 kg (4,500 lbs)									
LENGTH	1,588 mm (62.5 in)									
WIDTH	1,084 mm (42.7 in)									
HEIGHT	1,494.1 mm (58.8 in)									
GEAR RATIOS										
1ST	2ND	3RD	4TH	5TH	6TH	7TH	8TH	9TH	OVERALL	
2.95	2.55	2.17	1.82	1.57	1.33	1.16	1.00	0.85	3.47	

TA90-7601										
GROSS INPUT POWER	1,939 kW (2,600 hp) @1,900									
GROSS INPUT TORQUE	10,460 Nm (7,715 lb-ft)									
MAXIMUM INPUT SPEED	1,900 rpm									
WEIGHT, DRY	2,616 kg (5,767 lbs)									
LENGTH	1,851 mm (72.8 in)									
WIDTH	1,098 mm (43.2 in)									
HEIGHT	1,525 mm (60.0 in)									
GEAR RATIOS										
1ST	2ND	3RD	4TH	5TH	6TH	7TH	8TH	9TH	OVERALL	
4.45	3.84	3.26	2.74	2.36	2.01	1.75	1.51	1.28	3.48	

TA90-8501										
GROSS INPUT POWER	2,240 kW (3,000 hp) @2,100									
GROSS INPUT TORQUE	12,880 Nm (9,500 lb-ft)									
MAXIMUM INPUT SPEED	2,100 rpm									
WEIGHT, DRY	2,288 kg (5,020 lbs)									
LENGTH	1,367.1 mm (53.8 in)									
WIDTH	1,047 mm (41.2 in)									
HEIGHT	1,137 mm (44.8 in)									
GEAR RATIOS										
1ST	2ND	3RD	4TH	5TH	6TH	7TH	8TH	9TH	OVERALL	
4.47	3.57	2.85	2.41	1.92	1.54	1.25	1.00	0.80	5.60	

TA90-8703										
GROSS INPUT POWER	2,460 kW (3,300 hp) @1,900									
GROSS INPUT TORQUE	12,880 Nm (9,500 lb-ft)									
MAXIMUM INPUT SPEED	1,900 rpm									
WEIGHT, DRY	2,440 kg (5,380 lbs)									
LENGTH	1,434.2 mm (56.5 in)									
WIDTH	1,047.5 mm (41.2 in)									
HEIGHT	1,136.7 mm (44.8 in)									
GEAR RATIOS										
1ST	2ND	3RD	4TH	5TH	6TH	7TH	8TH	9TH	OVERALL	
4.47	3.57	2.85	2.41	1.92	1.54	1.25	1.00	0.80	5.60	

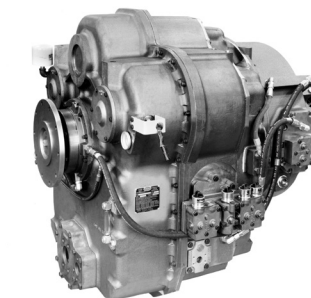
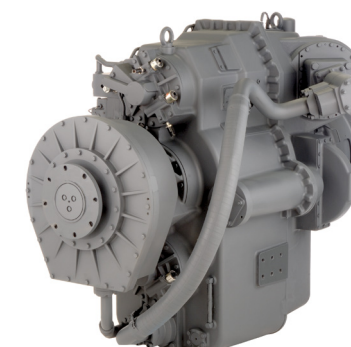
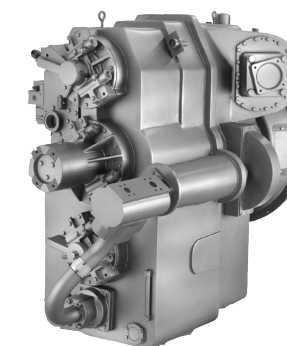

Scan for more information on transmissions

# HYDRAULIC TORQUE CONVERTERS

Twin Disc torque converters minimize engine lugging and stalling and permit engines to operate within their most efficient speed range, producing rated horsepower regardless of load demand. By transmitting torque entirely through fluid mass in motion, mechanical connection is eliminated. Twin Disc torque converters minimize or eliminate the need for shifting, clutching or declutching, resulting in more accurate control.

To meet the requirements of diesel installations up to 2,610 kW (3,500 hp), Twin Disc has a complete line of Type 8, single-stage hydraulic torque converters, available with and without a lock up clutch.

## FEATURES

- 1-Stage
- Type 8, up to 34"

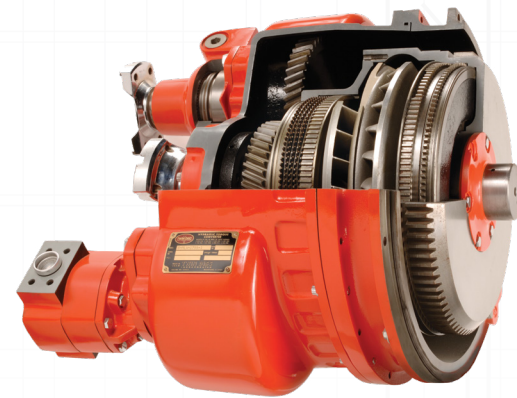

Scan for more information on hydraulic torque converters

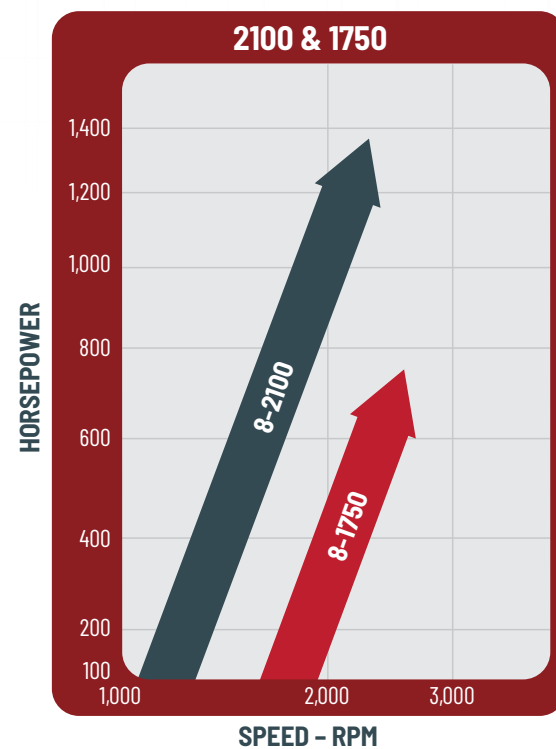
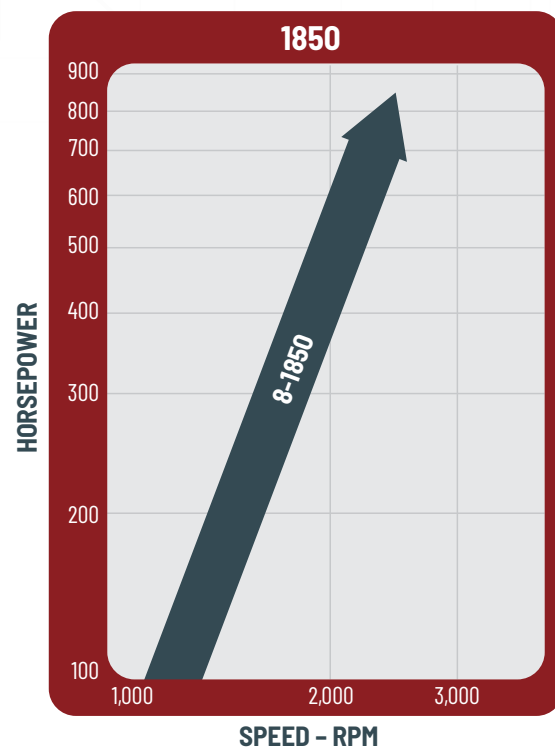

# UNIVERSAL CONTROL DRIVES

Used primarily to drive centrifugal pumps and fans, Twin Disc Universal Control Drives (UCDs) are an effective method of precisely and efficiently controlling various processes. They provide precise control of flow pressure, speed, torque or power. Twin Disc UCDs are available for power up to 3,000 kW (4,020 hp) at speeds up to 3,000 RPM. Please consult our Applications Engineering Department for more product information specific to your application.

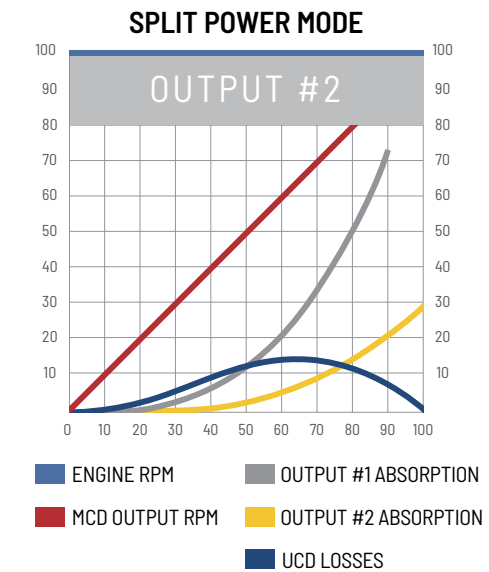
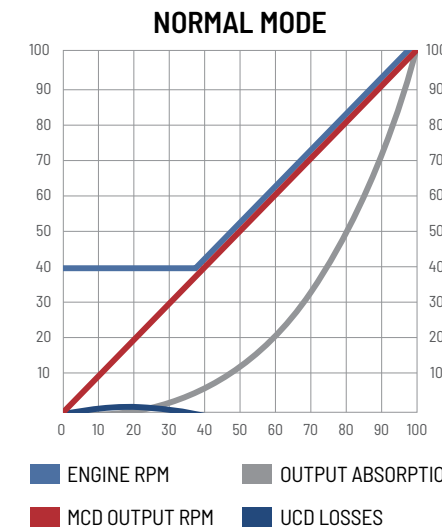
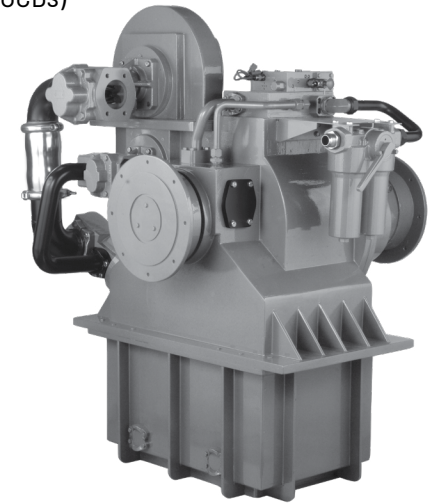

HD MODELS		
MODEL	kW/RPM	DISSIPATION
UCD-2000-1HD	1.20	100 kW
UCD-2000-2HD	1.60	130 kW
UCD-2000-3HD	2.00	160 kW
UCD-4000-1HD	2.40	190 kW
UCD-4000-2HD	2.80	225 kW
UCD-4000-3HD	3.20	250 kW
UCD-4000-4HD	3.60	290 kW
UCD-4000-5HD	3.75	330 kW
UCD-5000-1HD	3.75	400 kW
UCD-5000-2HD	3.75	450 kW

LD MODELS	
MODEL	kW/RPM
UCD-2000-1LD	1.20
UCD-2000-2LD	1.60
UCD-2000-3LD	2.00
UCD-4000-1LD	2.40
UCD-4000-2LD	2.80
UCD-4000-3LD	3.20
UCD-4000-4LD	3.60
UCD-4000-5LD	3.75

Scan for more information on UCDs

# ELECTRONIC CONTROLS

The TDEC-501 is the latest, advanced microprocessor-based electronic control system for use with Twin Disc automatic transmission systems in heavy-duty, off-highway applications.

More than just a shift control, the TDEC-501 integrates the transmission, engine and other powertrain systems to provide faster shifts, defined acceleration and correct control of vehicle or machine speed.

When used in oil field pressure-pumping applications, the fully configurable gear selection allows for precise and optimized control of the high-pressure piston pump and line-test modes.

Twin Disc HPTO & RC products use proportional solenoids and our proprietary clutch design to provide precise clutch engagement. These proportional solenoids cannot be connected direct to battery power; therefore, HPTO & RC are supplied with a TDEC-600 control module.

The TDEC-600 monitors engine speed and output speed for controlled engagement process to help ensure precise clutch engagement without overloading the engine or damaging the clutch while providing user interfaces for precise operation.

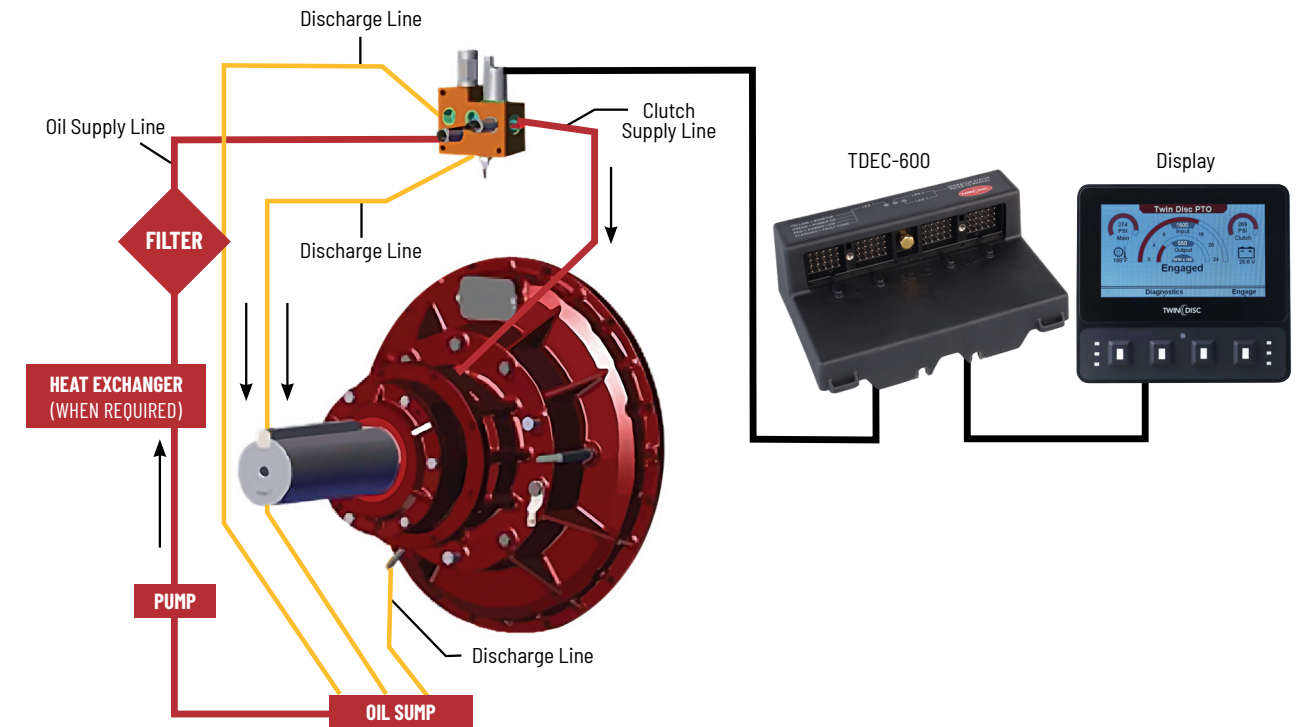

FEATURE	TDEC-600 (RC & HP CONTROL)	TDEC-501 (LAND-BASED TRANSMISSION)
MICROPROCESSOR-BASED	•	•
12/24 VDC NOMINAL	•	•
J1939 CAN BUS	•	•
ENGAGE/DISENGAGE SWITCH	•	•
LED SYSTEM STATUS FLASH	•	•
BUILT-IN-TEST (BIT) DIAGNOSTICS	•	•
ENGINE OUTPUT SPEED MONITORING	•	•
E-MARK CERTIFIED	•	•
ROHS COMPLIANT	•	•

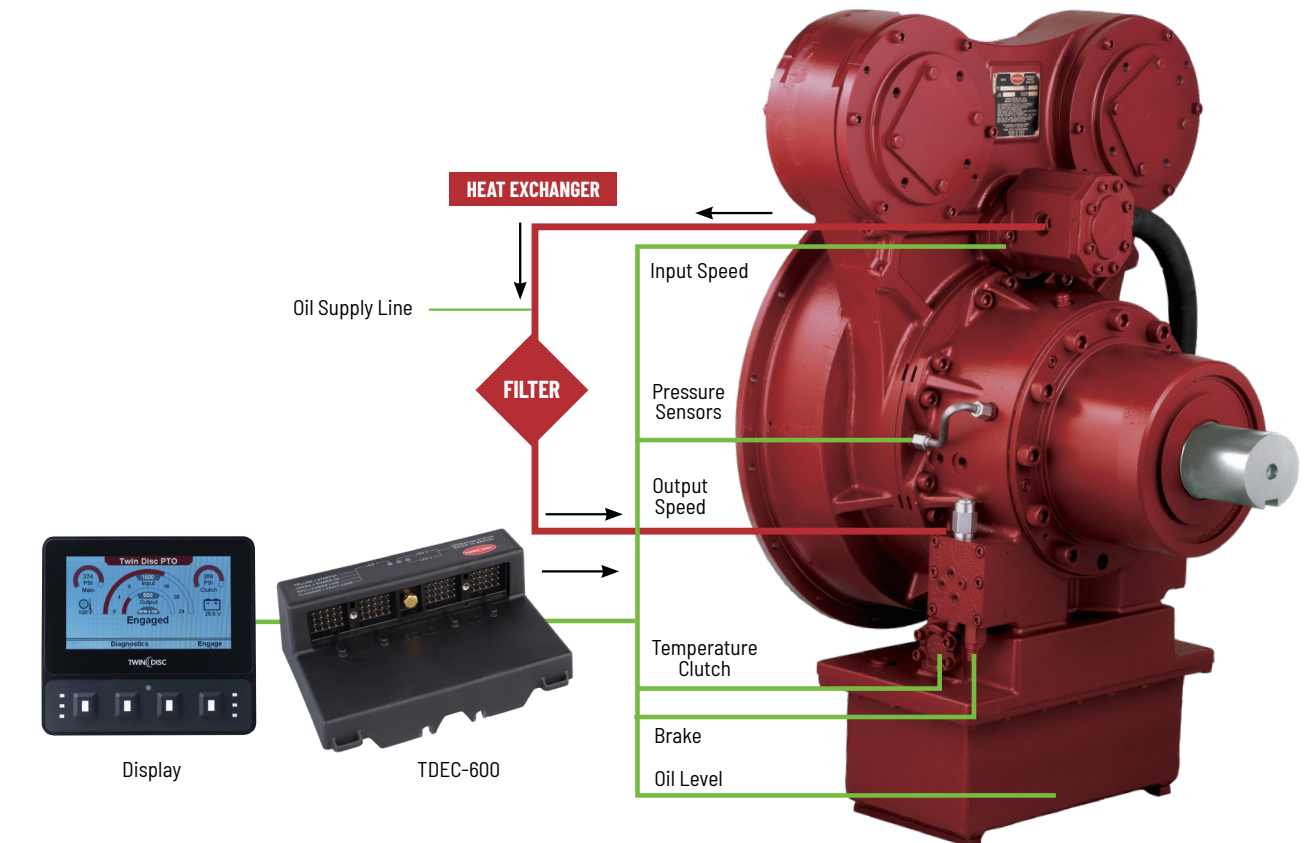

Scan for more information on electronic controls

GLOBAL MEANS

# A WORLD OF VALUE

## GLOBAL RESEARCH & DEVELOPMENT

Twin Disc has designed, built and serviced countless off-highway products all over the world for over a century. This unparalleled history of incorporating innumerable machines in varied operating conditions affords us a unique understanding of the global industry.

Our global R&D perspective yields innovative products relevant and important to individual customer applications.



## GLOBAL APPLICATION ENGINEERING

Our application engineers possess global experience and resources to help you select the most appropriate product for your application. Whatever the operating parameters, Twin Disc offers a knowledgeable and efficient solution to achieve the optimum combination of durability, productivity and cost-effectiveness.



## GLOBAL SALES & SERVICE

With 250 distributors and service dealers across the world, you've got genuine Twin Disc Parts and Service availability—wherever you are.

Our global network maintains an inventory of critical products and spare parts. In an emergency situation, our service team locates the available inventory nearest you and, combined with our after-hours emergency capabilities, gets you back underway right away.

To help you avoid the unforeseen, Twin Disc distributors and service dealers partner with you to review your specific application and recommend the most appropriate preventive and predictive maintenance program.



CONTINUE EXPLORING AT

# TWINDISC.COM

Your voyage doesn't end here – it's just the beginning! This brochure gave you a glimpse, but our website is your passport to more in-depth information to help you confidently navigate the challenging sea of new options.

## WHAT YOU WILL FIND

Comprehensive Product Information

Technical Specifications

Robust Sales & Service Locator

Resources, News and Events

And More

## YOUR CURIOSITY LED YOU HERE; NOW, LET OUR EXPERTISE GUIDE YOU.

Visit our website to take control of your journey and find out how we can put horsepower to work for you.



## MAKE TWIN DISC YOUR POWER PARTNER

Twin Disc will consult with you on your particular application to recommend the right product or system of products to ensure you'll obtain optimum performance from your machine. Our personal assistance in application design makes OEM "engineering in" easy and economical. Look no further for one-on-one support to help you discover what's right for your needs.

For assistance with a specific application, please email [applications@twindisc.com](mailto:applications@twindisc.com).



USA • AUSTRALIA • BELGIUM • CHINA • FINLAND • INDIA • ITALY • JAPAN • NETHERLANDS • SINGAPORE • SWITZERLAND



**WE PUT HORSEPOWER  
TO WORK<sup>®</sup>**

THE TWIN DISC FAMILY OF PRODUCTS



TWIN DISC, INCORPORATED • MILWAUKEE, WISCONSIN, USA • 262-638-4000 • TWINDISC.COM

©2024 TWIN DISC, INC • 2403\_BROCHURE\_ONLAND